

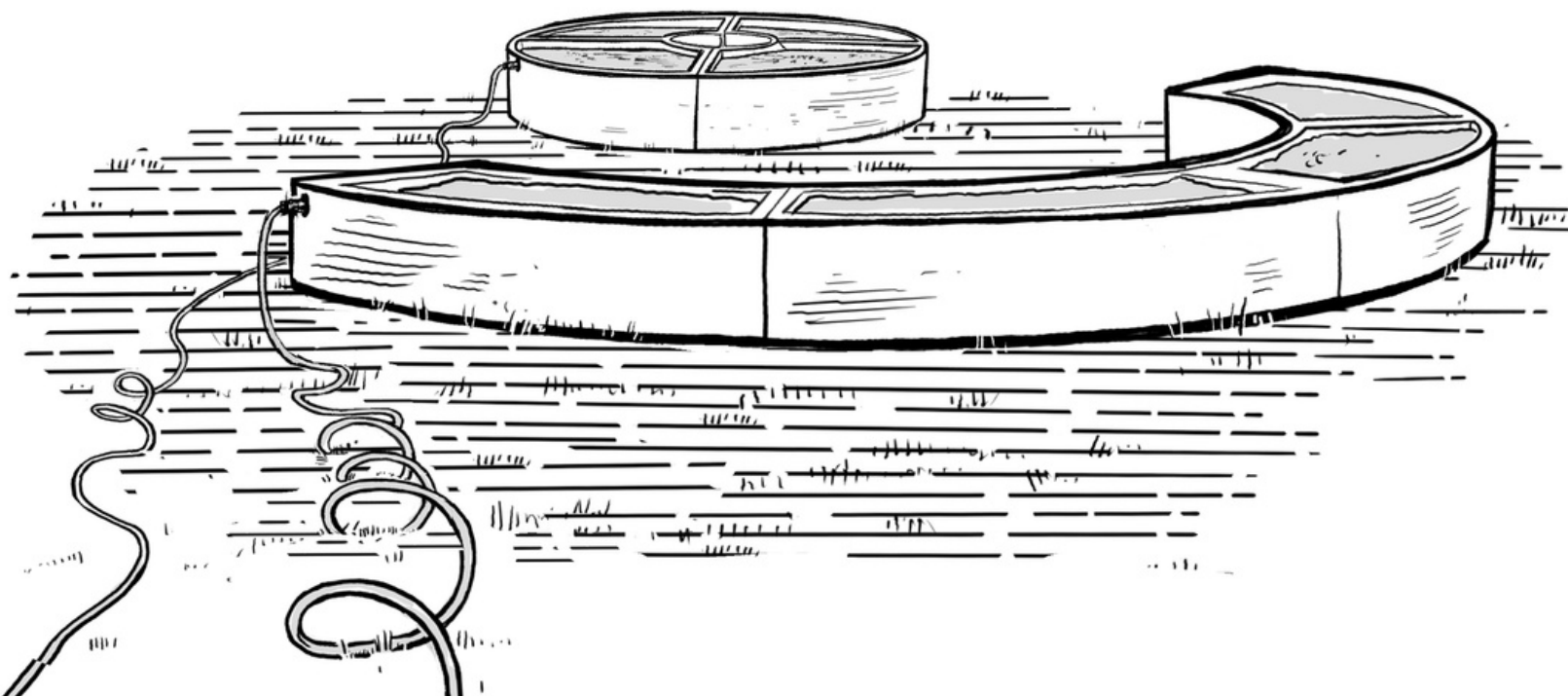

# HOW TO BUILD YOUR **LEARNING GARDEN**

a step-by-step instruction manual



# LET'S GROW!

This manual guides you from unpacking and placing your new Learning Garden to planting and watering with students. With step-by-step instructions, you'll be planting, watering, and watching your garden grow with your students in no time.

We've included QR codes throughout the guide that lead you to corresponding videos for each step. So, dig in and watch your garden come to life.



BIGGREEN.ORG/  
GARDENBUILD

- ☑ Start by finding the perfect spot for you garden. Some things to look for:
  - Is the surface flat?\*
  - Is there a functional water source within 50 feet?\*
  - Does the space receive at least 6-8 hours direct sun?\*
  - Do you have easy outdoor classroom access and use?
  - Does it fit into your school's traffic patterns and environment?

If you answered yes, congrats! You found the perfect spot for your garden! We understand it can be challenging to check all the boxes, everything with a (\*) is highly recommended.

- ☑ Gather all tools and ensure all Learning Garden kit items were delivered
- ☑ Create a watering schedule
- ☑ Coordinate your Learning Garden Kick-Off Day
  - Our Kickoff Day Guide includes suggestions, educational resources, and templates:



BIGGREEN.ORG/  
KICKOFF



# WELCOME TO THE LEARNING GARDEN COMMUNITY.

You've just joined thousands of passionate educators across the country who are introducing a new generation to the incredible power of growing food.

As you build and grow your garden, connect with this amazing community of like-minded educators. Share your progress, exchange ideas, and learn from others on social media.

- ✓ When you see the camera icon  note that these are key times to document with photos and videos.
- ✓ Pro Tip: Build days can get busy! Assign a volunteer or student to capture photos, videos, and stories throughout the day.
- ✓ Join Big Green's Educator Facebook Group – a place where new and experienced Learning Garden educators connect and share ideas:



[BIGGREEN.ORG/  
EDUCATORS](https://www.biggreen.org/educators)



**@BIGGREEN**



**Gather your tools! Here are the tools you'll need to build your garden:**

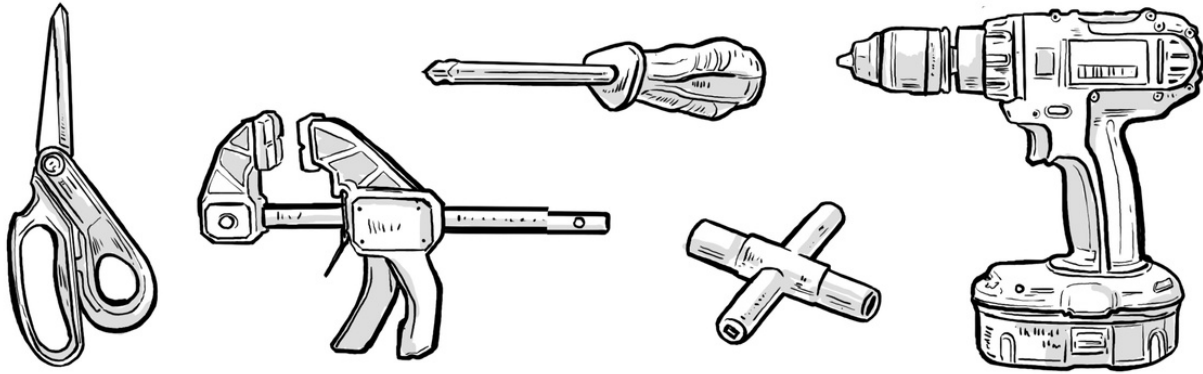

---

**These are some of the large items that will be delivered to your school:**

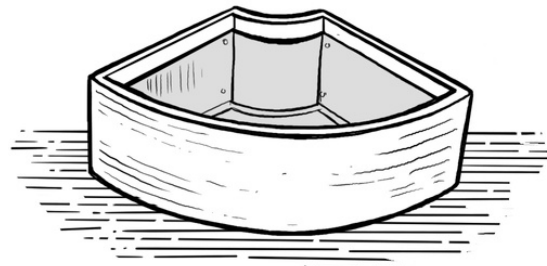
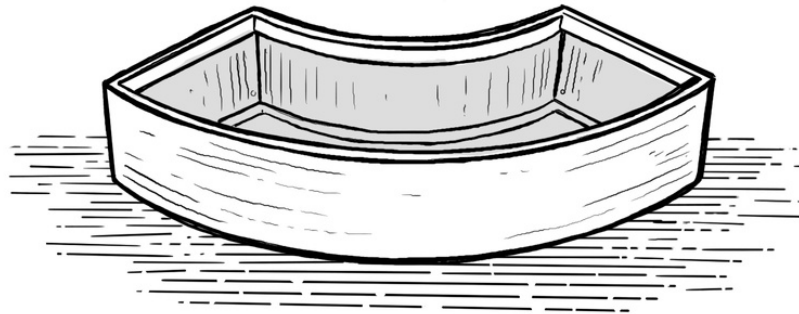

This is everything else that's included in your Learning Garden Kit (delivered inside of the storage box):

A.



B.



C.

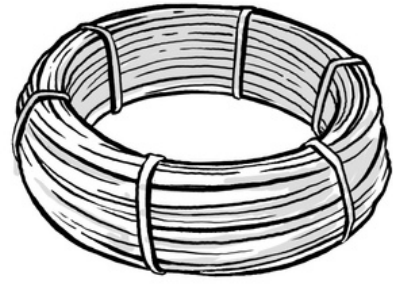

D.

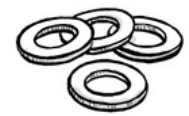

E.

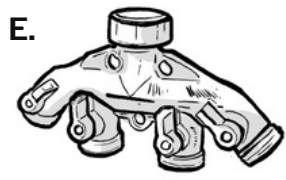

F.



G.



H.



I.



J.



K.



L.



M.



N.

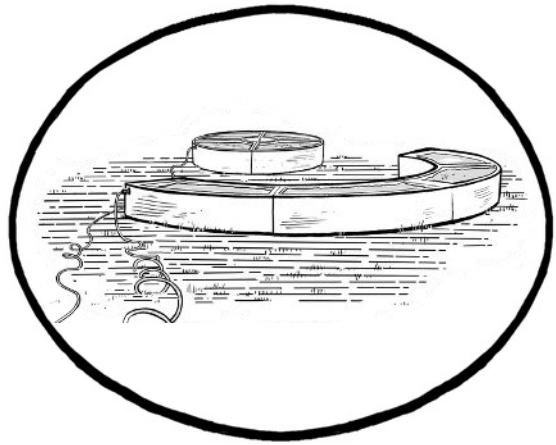
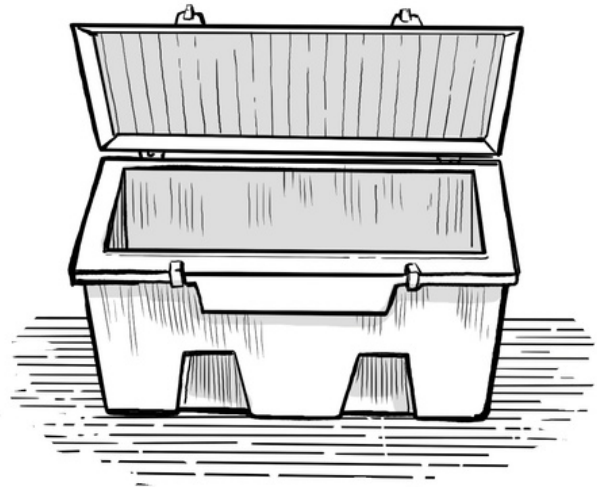
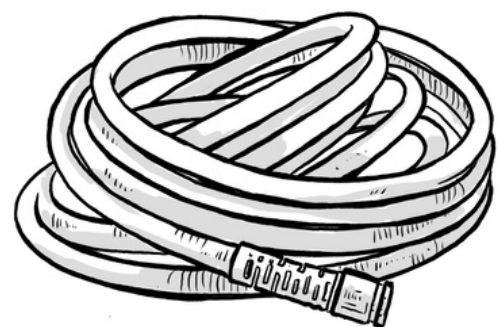

Now that you have all your tools and supplies, it's time to place Learning Garden beds:

Lift with your legs!

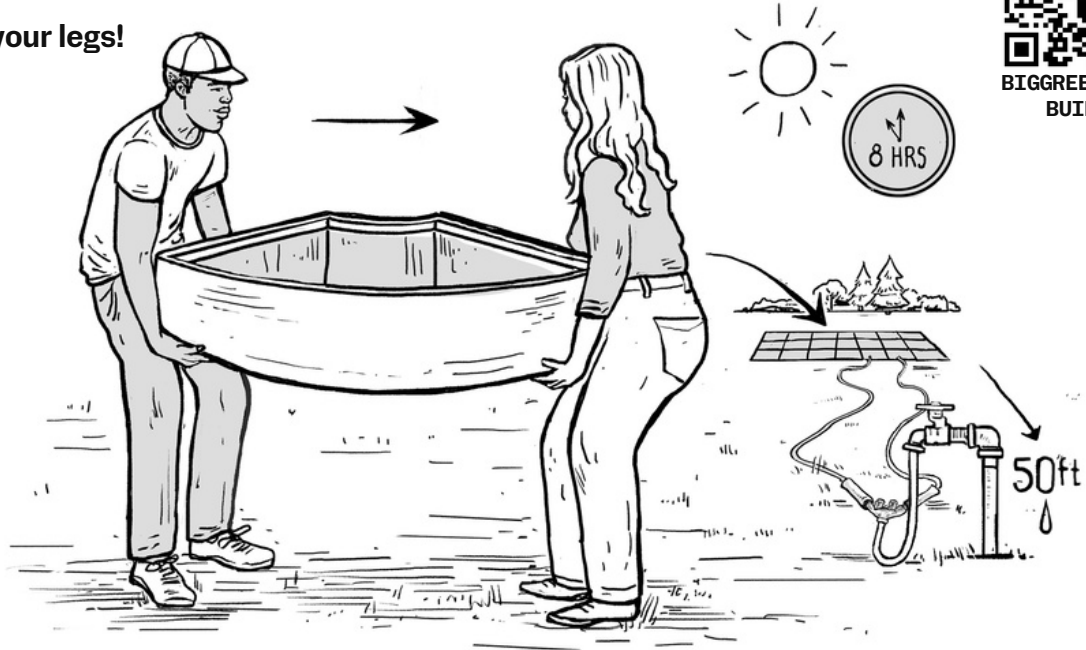

Next, you'll clamp, drill, and bolt the beds together:

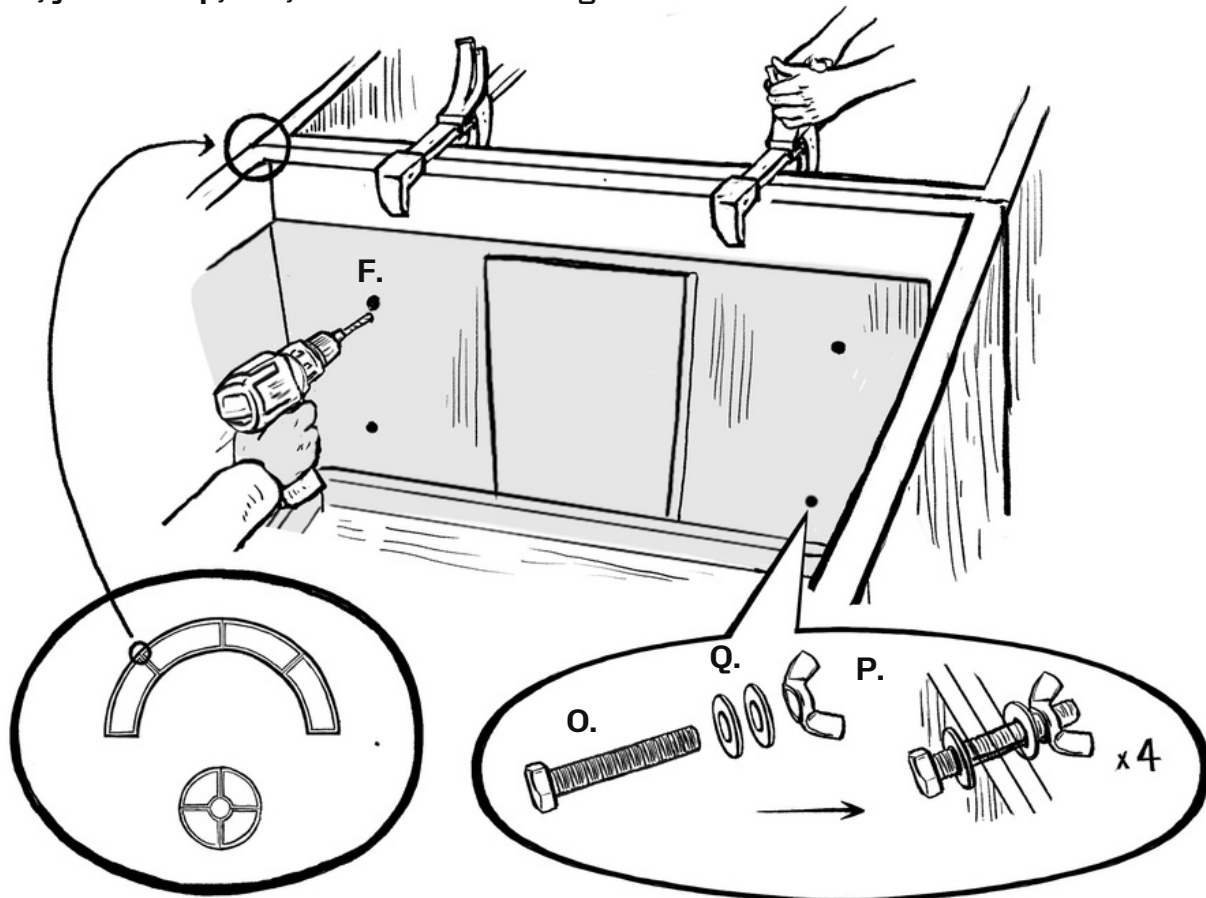

Drill 3, 3/4" holes for drip irrigation:



BIGGREEN.ORG/  
BUILD2

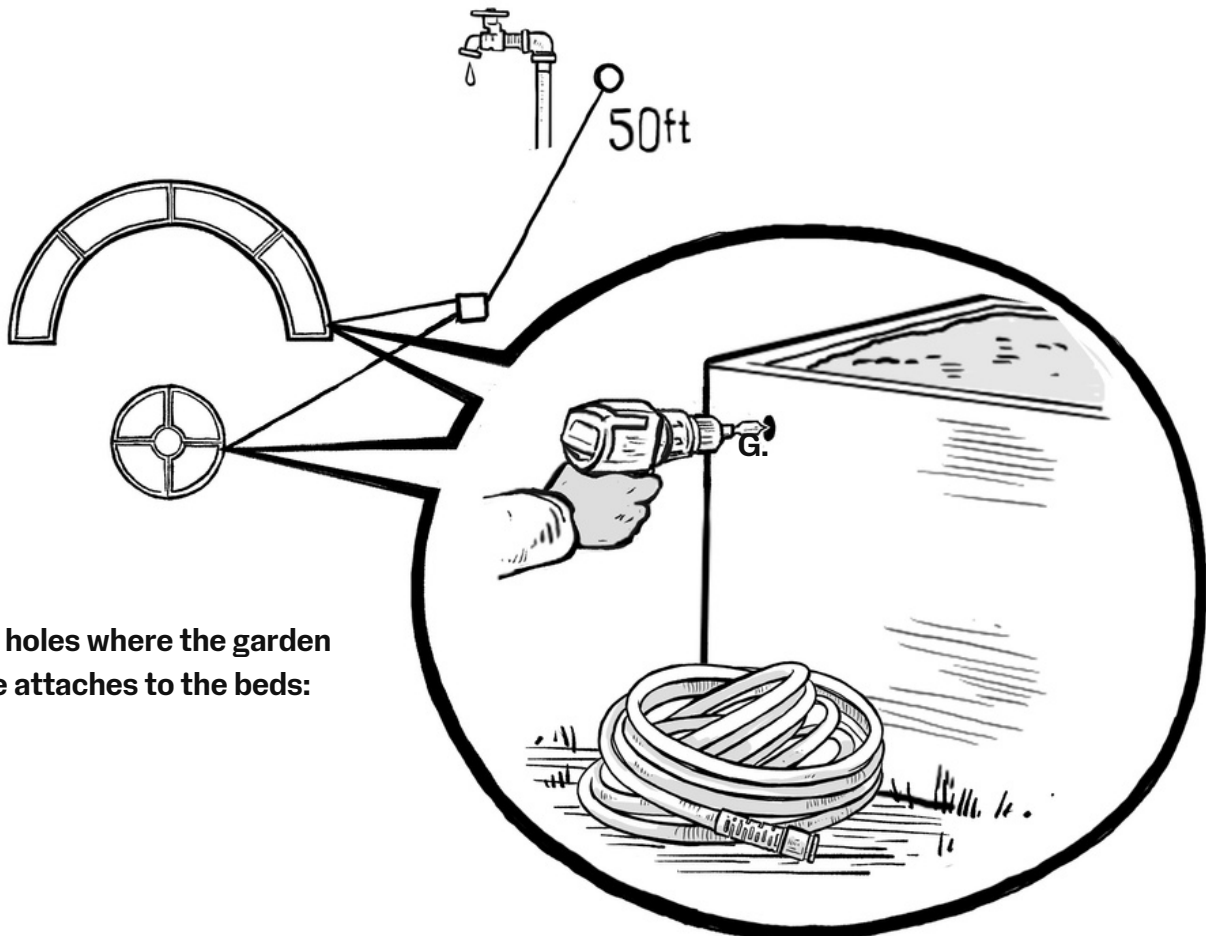
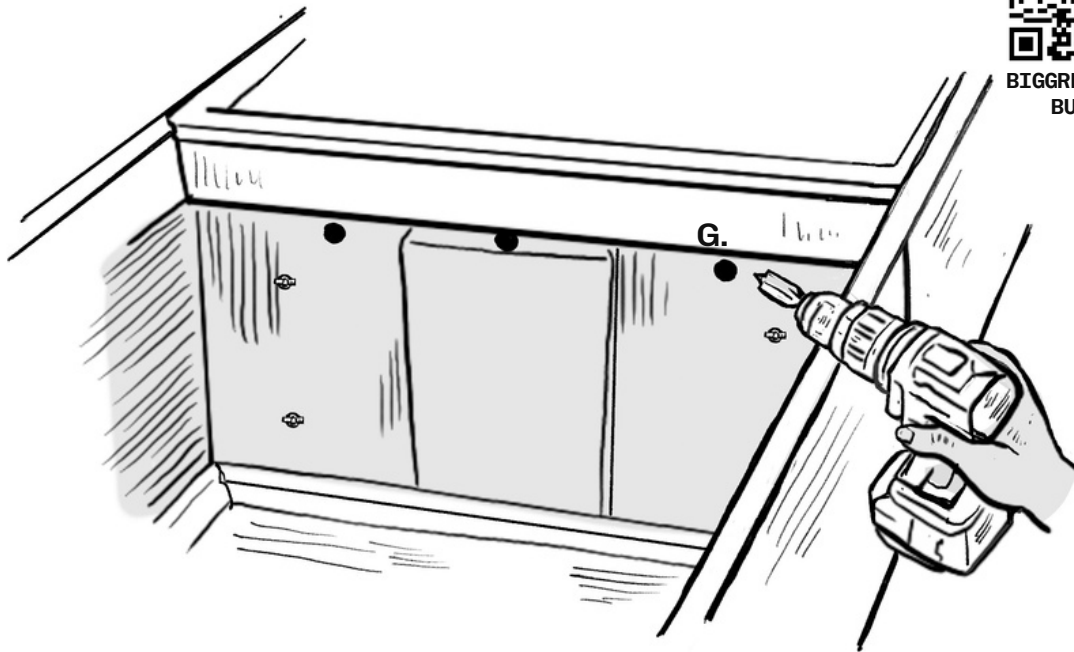

Drill holes where the garden  
hose attaches to the beds:

Install rubber washers and tape:

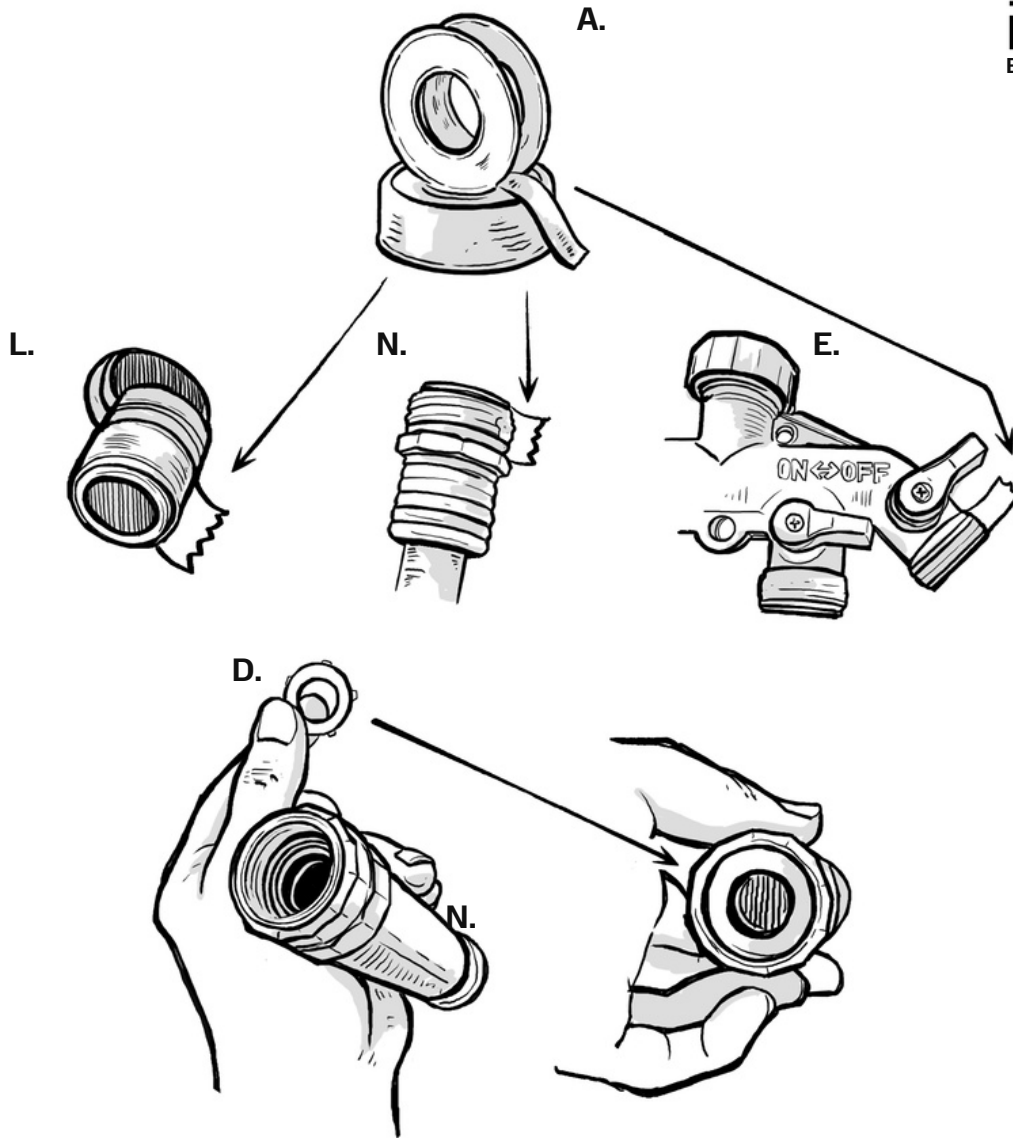

Attach the garden hose and drip line fitting:

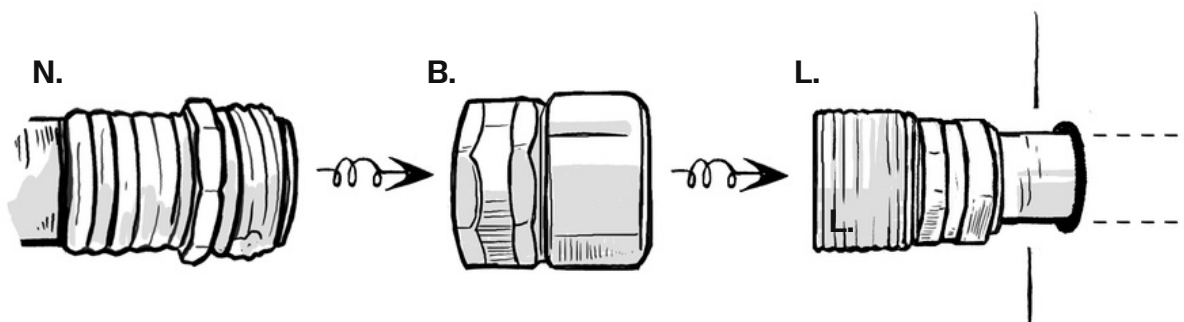



It's coming together! Now add soil to the beds:



BIGGREEN.ORG/  
BUILD4

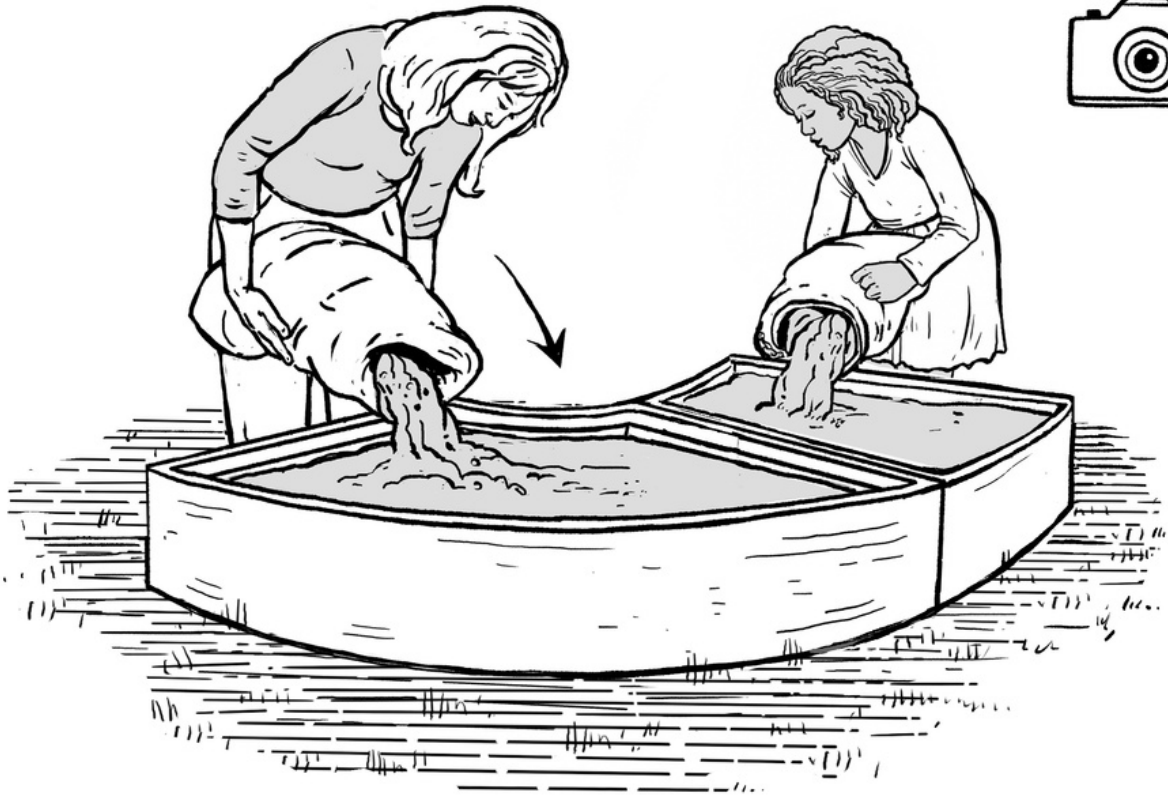

Press the potting mix into the beds and smooth the surface:

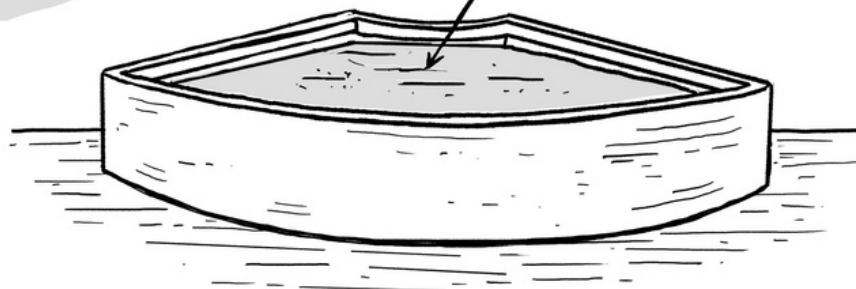
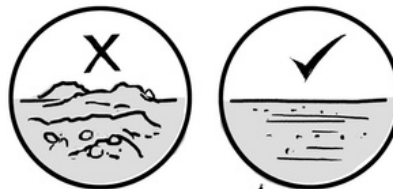
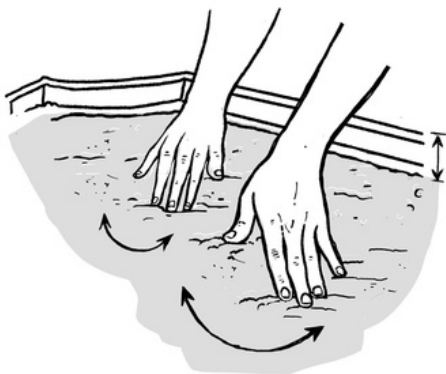

Ensure consistent watering and assemble the irrigation header:

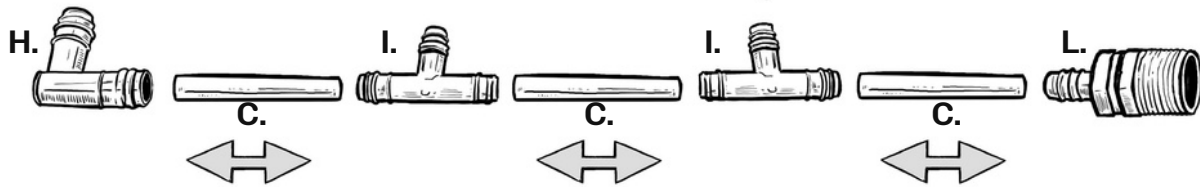
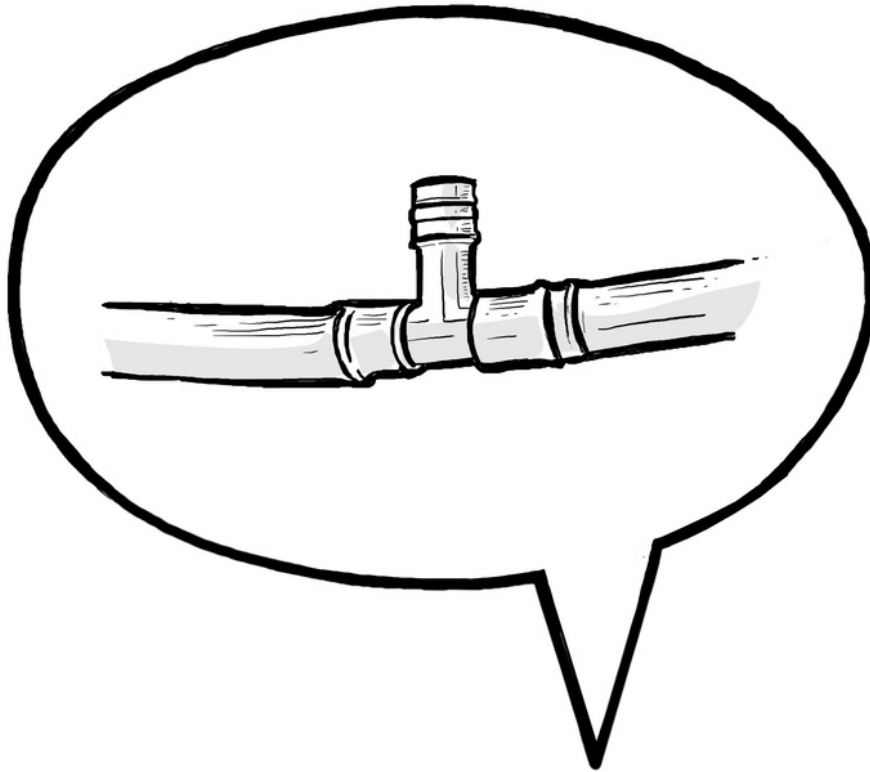

Fold and secure the ends:

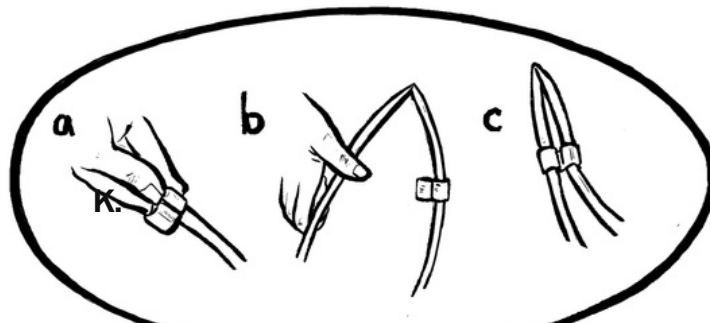

Thread the drip line:



Attach the threaded drip line to the irrigation header.

Connect the garden hose to the bed and water source with a 4-way splitter:

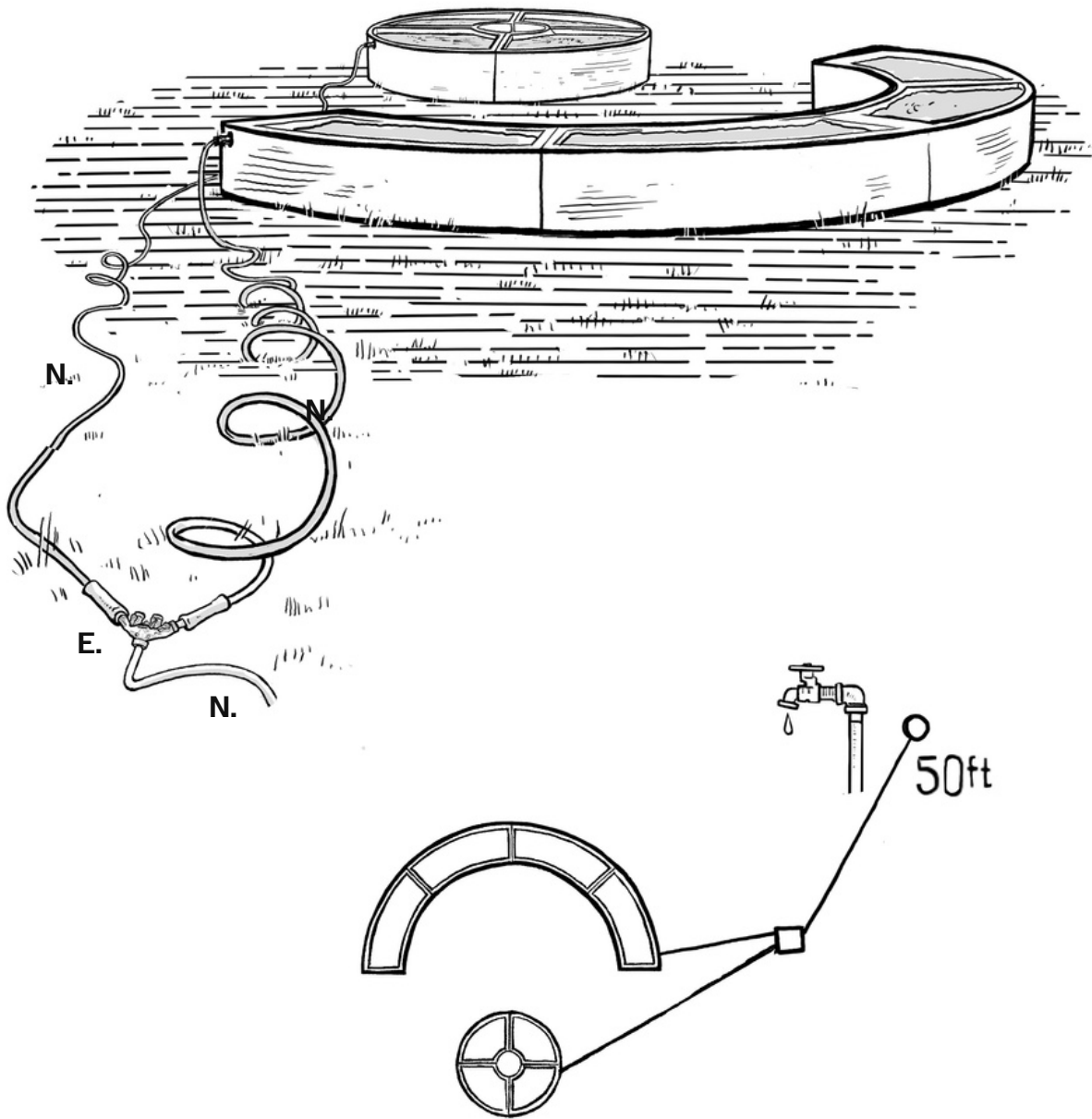

Plant your seeds by following the directions on your seed packets.

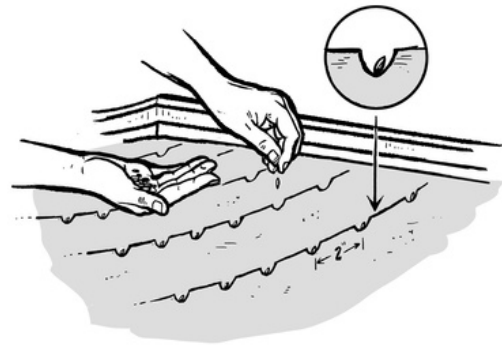
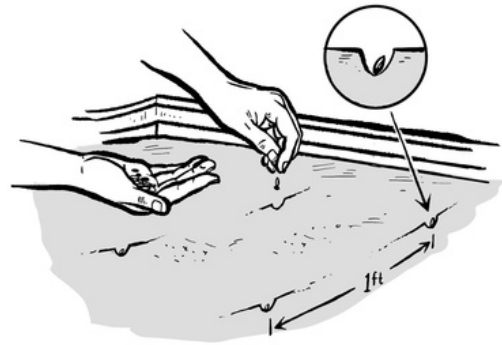

It's time to water your Learning Garden!



What you water will grow.

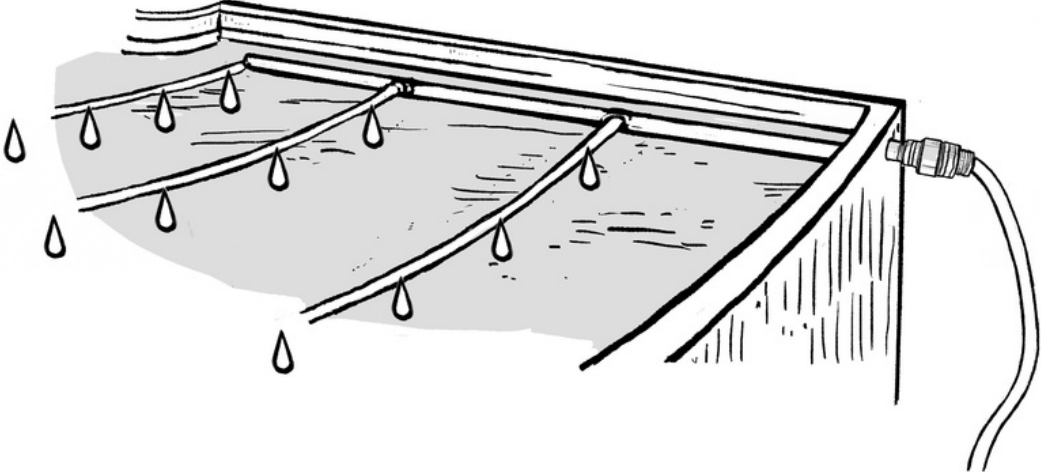

It's best to water daily to ensure you'll have a happy harvest.



You did it! Nice work. Take a moment to think about the space you've built, the things you're going to grow, and the lives you're bound to change.



**GROWING FOOD CHANGES LIVES.**



### **Questions?**

We're here to help!  
Get in touch with us,  
visit our Helpdesk.



[BIGGREEN.ORG/HELPDESK](https://BIGGREEN.ORG/HELPDESK)

**BIGGREEN.ORG**